

Compendium of Measures to Prevent Disease Associated with Animals in Public Settings, 2011

National Association of State Public Health Veterinarians, Inc.



Continuing Education Examination available at <http://www.cdc.gov/mmwr/cme/conted.html>



U.S. Department of Health and Human Services
Centers for Disease Control and Prevention

CONTENTS

Introduction	3
Methods	4
Enteric (Intestinal) Diseases	4
Outbreaks and Lessons Learned	4
Sporadic Infections	6
Additional Health Concerns	7
Injuries	7
Exposure to Rabies	7
Other Infections	7
Recommendations	8
Recommendations for Local, State, and Federal Agencies.....	9
Recommendations for Education	9
Recommendations for Managing Public-Animal Contact	10
Animal Care and Management	11
Additional Recommendations	12
References.....	12
Appendix A.....	18
Appendix B	19
Appendix C.....	20
Appendix D.....	22

On the Cover: *Top left:* Girl and a sheep at a petting zoo (Photo/Champlain Valley Exposition, Essex Junction, Vermont). *Top right:* Brushing a pig at a petting zoo (Photo/C. Barton Behravesh, CDC). *Bottom right:* Boy and a calf at an animal exhibit in Minnesota (Photo/J. Springfield, V. A. Medical Center, Minneapolis, Minnesota). *Bottom left:* People looking at hatchling chicks at a chick exhibit (Photo/M. Calico, International Association of Fairs and Expositions). *Center:* Hand washing after animal contact (Photo/J. Smith).

The *MMWR* series of publications is published by the Office of Surveillance, Epidemiology, and Laboratory Services, Centers for Disease Control and Prevention (CDC), U.S. Department of Health and Human Services, Atlanta, GA 30333.

Suggested Citation: Centers for Disease Control and Prevention. [Title]. *MMWR* 2011;60(No. RR-#):[inclusive page numbers].

Centers for Disease Control and Prevention

Thomas R. Frieden, MD, MPH, *Director*
 Harold W. Jaffe, MD, MA, *Associate Director for Science*
 James W. Stephens, PhD, *Office of the Associate Director for Science*
 Stephen B. Thacker, MD, MSc, *Deputy Director for Surveillance, Epidemiology, and Laboratory Services*
 Stephanie Zaza, MD, MPH, *Director, Epidemiology and Analysis Program Office*

MMWR Editorial and Production Staff

Ronald L. Moolenaar, MD, MPH, <i>Editor, MMWR Series</i>	Malbea A. LaPete, Julia C. Martinroe,
Christine G. Casey, MD, <i>Deputy Editor, MMWR Series</i>	Stephen R. Spriggs, Terraye M. Starr
Teresa F. Rutledge, <i>Managing Editor, MMWR Series</i>	<i>Visual Information Specialists</i>
David C. Johnson, <i>Lead Technical Writer-Editor</i>	Quang M. Doan, MBA, Phyllis H. King
Martha F. Boyd, <i>Lead Visual Information Specialist</i>	<i>Information Technology Specialists</i>

MMWR Editorial Board

William L. Roper, MD, MPH, Chapel Hill, NC, <i>Chairman</i>	Patricia Quinlisk, MD, MPH, Des Moines, IA
Virginia A. Caine, MD, Indianapolis, IN	Patrick L. Remington, MD, MPH, Madison, WI
Jonathan E. Fielding, MD, MPH, MBA, Los Angeles, CA	Barbara K. Rimer, DrPH, Chapel Hill, NC
David W. Fleming, MD, Seattle, WA	John V. Rullan, MD, MPH, San Juan, PR
William E. Halperin, MD, DrPH, MPH, Newark, NJ	William Schaffner, MD, Nashville, TN
King K. Holmes, MD, PhD, Seattle, WA	Anne Schuchat, MD, Atlanta, GA
Deborah Holtzman, PhD, Atlanta, GA	Dixie E. Snider, MD, MPH, Atlanta, GA
John K. Iglehart, Bethesda, MD	John W. Ward, MD, Atlanta, GA
Dennis G. Maki, MD, Madison, WI	

Compendium of Measures to Prevent Disease Associated with Animals in Public Settings, 2011

National Association of State Public Health Veterinarians, Inc. (NASPHV)

Prepared by
NASPHV

Summary

Certain venues encourage or permit the public to be in contact with animals, resulting in millions of human-animal interactions each year. These settings include county or state fairs, petting zoos, animal swap meets, pet stores, feed stores, zoologic institutions, circuses, carnivals, educational farms, livestock-birthing exhibits, educational exhibits at schools and child-care facilities, and wildlife photo opportunities. Although human-animal contact has many benefits, human health problems are associated with these settings, including infectious diseases, exposure to rabies, and injuries. Infectious disease outbreaks have been caused by Escherichia coli O157:H7, Salmonella species, Cryptosporidium species, Coxiella burnetii, Mycobacterium tuberculosis, ringworm, and other pathogens. Such outbreaks have substantial medical, public health, legal, and economic effects.

This report provides recommendations for public health officials, veterinarians, animal venue staff members, animal exhibitors, visitors to animal venues, physicians, and others concerned with minimizing risks associated with animals in public settings. The recommendation to wash hands is the most important for reducing the risk for disease transmission associated with animals in public settings. Other important recommendations are that venues prohibit food in animal areas and include transition areas between animal areas and nonanimal areas, visitors receive information about disease risk and prevention procedures, and animals be properly cared for and managed. These updated 2011 guidelines provide new information on the risks associated with amphibians and with animals in day camp settings, as well as the protective role of zoonotic disease education.

Introduction

Contact with animals in public settings (e.g., fairs, educational farms, petting zoos, and schools) provides opportunities for entertainment and education. The National Association of State Public Health Veterinarians (NASPHV) understands the positive benefits of human-animal contact. However, an inadequate understanding of disease transmission and animal behavior can increase the likelihood of infectious diseases, rabies exposures, injuries, and other health problems among visitors, especially children, in these settings. Zoonotic diseases (i.e., zoonoses) are diseases transmitted between animals and humans. Of particular concern are instances in which zoonoses result in numerous persons becoming ill. During 1991–2005, the number of enteric disease outbreaks associated with animals

in public settings increased (1). During 1996–2010, approximately 150 human infectious disease outbreaks involving animals in public settings have been reported to CDC (CDC, unpublished data, 2010).

Although eliminating all risk from animal contacts is not possible, this report provides recommendations for minimizing associated disease and injury. NASPHV recommends that local and state public health, agricultural, environmental, and wildlife agencies use these recommendations to establish their own guidelines or regulations for reducing the risk for disease from human-animal contact in public settings. Public contact with animals is permitted in numerous types of venues (e.g., animal displays, petting zoos, animal swap meets, pet stores, feed stores, zoological institutions, nature parks, circuses, carnivals, educational farms, livestock-birthing exhibits, county or state fairs, child-care facilities or schools, and wildlife photo opportunities). Managers of these venues should use the information in this report in consultation with veterinarians, public health officials, or other professionals to reduce risks for disease transmission.

Guidelines to reduce risk for disease from animals in health-care and veterinary facilities and from service animals (e.g., guide dogs) have been developed (2–6). Although not specifically addressed here, the general principles and recommendations in this report are applicable to these settings.

This report has been endorsed by CDC, the Council of State and Territorial Epidemiologists, the United States Department of Agriculture-Animal Plant Health Inspection Service, the American Association of Extension Veterinarians, and the American Veterinary Medical Association.

Corresponding preparer: John R. Dunn, DVM, Co-chairperson, NASPHV Animal Contact Compendium Committee, Tennessee Department of Health, 425 5th Avenue North, Cordell Hull Building, 1st Floor, Nashville, TN 37243. Telephone: 615-741-5948; Fax: 615-741-3857; e-mail: John.Dunn@tn.gov.

Methods

NASPHV periodically updates the recommendations to prevent disease associated with animals in public settings. The revision includes reviewing recent literature; updating reported outbreaks, diseases, or injuries attributed to human-animal interactions in public settings; and soliciting input from NASPHV members and the public. During September 15–17, 2010, NASPHV members and external expert consultants met at CDC in Atlanta, Georgia. A committee consensus was required to add or modify existing language or recommendations. The 2011 guidelines have been updated with recently reported information about zoonotic disease outbreaks and prevention measures. This includes more information on indirect transmission through contact with animal environments and contaminated objects and unique challenges associated with intensive animal contact venues like farm day camps. In addition, the guidelines describe the importance of previous knowledge about disease risk in preventing illness. New or expanded disease topics include salmonellosis associated with amphibians and zoonotic influenza.

Enteric (Intestinal) Diseases

Infections with enteric bacteria and parasites pose the highest risk for human disease from animals in public settings (7). Healthy animals can harbor human enteric pathogens, many of which have a low infectious dose (8–10). Enteric disease outbreaks among visitors to fairs, farms, petting zoos, and other public settings are well documented. Many pathogens have been responsible for outbreaks, including *Escherichia coli* O157:H7 and other Shiga toxin-producing *E. coli* (STEC), *Salmonella enterica*, *Cryptosporidium* species, and *Campylobacter* species (11–24). Although reports often document cattle, sheep, or goats (1,13,14) as sources for infection, live poultry (25), rodents (26), reptiles (19), amphibians (27), and other domestic and wild animals also are potential sources.

The primary mode of transmission for enteric pathogens is fecal-oral. Because animal fur, hair, skin, and saliva (28) harbor fecal organisms, transmission can occur when persons pet, touch, feed, or are licked by animals. Transmission also has been associated with contaminated animal bedding, flooring, barriers, other environmental surfaces, and contaminated clothing and shoes (12,17,19,29–32). In addition, illness has resulted from fecal contamination of food (33), including raw milk (34–37), and drinking water (38–40).

Removing ill animals, especially those with diarrhea, is necessary but not sufficient to protect animal and human health. Animals carrying human enteric pathogens frequently exhibit no signs of illness but can still shed the organisms,

thereby contaminating the environment (41). Some pathogens are shed by animals intermittently and live for months or years in the environment (42–46). Intermittent shedding of pathogens and limitations of laboratory testing make attempts to identify and remove infected animals unreliable as a means of eliminating the risk for transmission. Antimicrobial treatment of animals also cannot reliably eliminate infection, prevent shedding, or protect against reinfection. In addition, treatment of animals can prolong shedding and contribute to antimicrobial resistance (47).

Multiple factors increase the probability of disease transmission at animal exhibits. Animals are more likely to shed pathogens because of stress induced by prolonged transportation, confinement, crowding, and increased handling (48–54). Commingling increases the probability that animals shedding pathogens will infect other animals (55). The prevalence of certain enteric pathogens is often higher in young animals (56–58), which are frequently used in petting zoos and educational programs for children. Shedding of STEC and *Salmonella* organisms is highest in the summer and fall, when substantial numbers of traveling animal exhibits, agricultural fairs, and petting zoos are scheduled (53,58,59).

The risk for human infection is increased by certain factors and behaviors, especially in children. These factors and behaviors include lack of awareness of the risk for disease, inadequate hand washing, lack of close supervision, and hand-to-mouth activities (e.g., use of pacifiers, thumb-sucking, and eating) (60). Children are particularly attracted to animal venues but have increased risk for serious illness when they are infected. Although farm residents might have some acquired immunity to certain pathogens (61,62), livestock exhibitors have become infected with *E. coli* O157:H7 in fair outbreaks (17; K. Smith, DVM, Minnesota Department of Health, personal communication, 2010).

The layout and maintenance of facilities and animal exhibits can increase or decrease the risk for infection (63). Factors that increase risk include inadequate hand-washing facilities (64), inappropriate flow of visitors, and incomplete separation between animal exhibits and food preparation and consumption areas (12,16,65). Other factors include structural deficiencies associated with temporary food-service facilities, contaminated or inadequately maintained drinking water systems, and poorly managed sewage- or manure-disposal (19,32,38–40).

Outbreaks and Lessons Learned

In 2000, two *E. coli* O157:H7 outbreaks in Pennsylvania and Washington prompted CDC to establish recommendations for enteric disease prevention associated with farm animal contact. Risk factors identified in both outbreaks were direct

animal contact and inadequate hand washing (15,66). In the Pennsylvania outbreak, 51 persons (median age: 4 years) became ill within 10 days after visiting a dairy farm. Eight (16%) of these patients acquired hemolytic uremic syndrome (HUS), a potentially fatal complication of STEC infection which involves kidney failure. The same strain of *E. coli* O157:H7 was isolated from cattle, patients, and the farm environment. An assessment of the farm determined that no areas separate from the animal contact areas existed for eating and drinking, and the hand-washing facilities were poorly maintained and not configured for children (15).

The protective effect of hand washing and the persistence of organisms in the environment were demonstrated in an outbreak of *Salmonella enterica* serotype Enteritidis infections at a Colorado zoo in 1996. A total of 65 cases (primarily among children) were associated with touching a wooden barrier around a temporary Komodo dragon exhibit. Children who were not ill were significantly more likely to have washed their hands after visiting the exhibit. *Salmonella enterica* serotype Enteritidis was isolated from 39 patients, a Komodo dragon, and the wooden barrier (19).

In 2005, an *E. coli* O157:H7 outbreak among 63 patients, including seven who developed HUS, was associated with multiple fairs in Florida (13). Both direct animal contact and contact with sawdust or shavings were associated with illness. Persons who reported feeding animals were more likely to become ill. Persons were less likely to become ill if they reported washing their hands before eating or drinking. Among persons who washed their hands with soap and water, creating lather decreased the likelihood of illness, illustrating the value of thorough hand washing. Drying hands on clothing increased the likelihood of illness (67).

During 2000–2001 at a Minnesota children's farm day camp, washing hands with soap after touching a calf and washing hands before going home decreased the likelihood for illness in two outbreaks involving multiple enteric pathogens (22). Implicated pathogens for the 84 human infections were *E. coli* O157:H7, *Cryptosporidium parvum*, non-O157 STEC, *Salmonella enterica* serotype Typhimurium, and *Campylobacter jejuni*. These pathogens and *Giardia* organisms were isolated from calves. Risk factors for children who became ill included caring for an ill calf and getting visible manure on their hands.

Disease transmission can occur in the absence of direct animal contact if a pathogen is disseminated in the environment. In a 2002 Oregon county fair outbreak, 60 *E. coli* O157:H7 infections occurred, primarily among children (29). Illness was associated with visiting an exhibition hall that housed goats, sheep, pigs, rabbits, and poultry; however, illness was not associated with touching animals or their pens, eating, or inadequate hand washing. *E. coli* O157:H7 was likely

disseminated to environmental surfaces via contaminated dust (29). In 2004, an outbreak of *E. coli* O157:H7 infections was associated with attendance at the North Carolina State Fair goat and sheep petting zoo (14). Health officials identified 108 patients, including 15 who developed HUS. In addition to direct contact with animals, risk factors included manure contact and hand-to-mouth behaviors. Evidence indicated that falling down or sitting on the ground in the petting zoo was associated with illness. The outbreak strain of *E. coli* O157:H7 was isolated from shoes and shavings collected from a stroller in households of petting zoo visitors (14).

Enteric pathogens can contaminate the environment and persist in animal housing areas for long periods. For example, *E. coli* O157:H7 can survive in soil for months (32,42,44,68,69). Prolonged environmental persistence of pathogens was documented in a 2001 Ohio outbreak of *E. coli* O157:H7 infections in which 23 persons became ill at a fair facility after handling sawdust, attending a dance, or eating and drinking in a barn where animals had been exhibited during the previous week (32). Fourteen weeks after the fair, *E. coli* O157:H7 was isolated from multiple environmental sources within the barn, including sawdust on the floor and dust on the rafters. Forty-two weeks after the fair, *E. coli* O157:H7 was again recovered from sawdust on the floor. Environmental persistence of *E. coli* O157:H7 was also described after a 2003 outbreak in which 25 persons acquired *E. coli* O157:H7 at a Texas agricultural fair. The strain isolated from patients also was found in fair environmental samples 46 days after the fair ended (17). In the previously mentioned North Carolina outbreak (14), the outbreak strain of *E. coli* O157:H7 was isolated from animal bedding 10 days after the fair was over and from soil 5 months after the animal bedding and topsoil were removed (14,69).

Improper facility design and inadequate maintenance can increase risk for infection, as illustrated by one of the largest waterborne outbreaks in the United States (39,40). In 1999, approximately 800 suspected cases of *E. coli* O157:H7 and/or *Campylobacter* species infection were identified among attendees at a New York county fair, where unchlorinated water supplied by a shallow well was used by food vendors to make beverages and ice (40).

Temporary animal exhibits are particularly vulnerable to design flaws (13,19). Such exhibits include animal displays or petting zoos added to attract visitors to zoos, festivals, roadside attractions, farm stands, farms where persons can pick their own produce, feed stores, and Christmas tree lots. In 2005, an *E. coli* O157:H7 outbreak in Arizona was associated with a temporary animal contact exhibit at a municipal zoo. A play area for children was immediately adjacent to and downhill from the petting zoo facility. The same strain of

E. coli O157:H7 was found both in children and 12 petting zoo animals. Inadequate hand-washing facilities were reported from a temporary exhibit in British Columbia, Canada where child-care facility and school field trips to a pumpkin patch with a petting zoo resulted in 44 cases of *E. coli* O157:H7 infection (16). The same strain of *E. coli* O157:H7 was found both in children and in a petting zoo goat. Running water and signs recommending hand washing were not available, and alcohol hand sanitizers were at a height that was unreachable for some children. In New York, 163 persons became ill with STEC O111:H8, *Cryptosporidium* species, or both at a farm stand that sold unpasteurized apple cider and had a petting zoo with three calves (70). Stools from two calves were Shiga toxin 1 positive.

Day camps at which children have prolonged close contact with livestock pose a unique challenge with regard to disease prevention. In the previously mentioned Minnesota day camp outbreak (22), disease transmission occurred again even though heightened prevention measures were implemented based on findings from an outbreak investigation at the same camp the year before. Similarly, in 2007, an *E. coli* O157:H7 outbreak occurred at a day camp in Florida where prolonged contact with livestock was encouraged (71).

Recurrent outbreaks have happened because of failure to properly implement disease-prevention recommendations. Following a Minnesota outbreak of cryptosporidiosis with 31 ill students at a school farm program, specific recommendations provided to teachers were inadequately implemented (20), and a subsequent outbreak occurred with 37 illnesses. Hand-washing facilities and procedures were inadequate. Coveralls and boots were dirty, cleaned infrequently, and handled without subsequent hand washing.

Education of visitors to public animal contact venues about the risk for transmission of diseases from animals to humans is a critical disease-prevention measure. Awareness of zoonotic disease risks is protective against illness in outbreaks (14).

Outbreaks also have resulted from contaminated animal products used for school activities. Salmonellosis outbreaks associated with dissection of owl pellets have been documented in Minnesota (72) and Massachusetts (C. Brown, DVM, Massachusetts Department of Public Health, personal communication, 2008). In Minnesota, risk factors for infection included inadequate hand washing, use of food service areas for the activity, and improper cleaning of contact surfaces. Persons in a middle school science class were among those infected in a multistate salmonellosis outbreak associated with frozen rodents purchased to feed snakes from the same Internet supplier (26).

During 2005–2010, several infectious disease outbreaks were caused by contact with animals and animal products

not primarily associated with public settings. However, these outbreaks have implications for animal contact venues. Turtles and other reptiles, amphibians, rodents, and live poultry (e.g., chicks, chickens, ducklings, ducks, turkeys, and geese) are recognized as sources of human *Salmonella* infections (19,25,27,73–83). Since 2006, three large multistate outbreaks have been linked to contact with small turtles, including a fatal case in an infant (79,80,84–86). In addition, 14 multistate outbreaks linked with live poultry originating from mail-order hatcheries have been reported since 2005 (CDC, unpublished data, 2010). Ill persons included those who reported contact with live poultry at feed stores, schools, day cares, fairs, or petting zoos (78). During 2006–2008, a total of 79 human *Salmonella enterica* serotype Schwarzengrund infections were linked to multiple brands of contaminated dry dog and cat food produced at a plant in Pennsylvania (87). Contaminated pig ear treats and pet treats containing beef and seafood also have been associated with *Salmonella* infections (88–91).

Risks from aquatic animals include direct and indirect contact with the animal, tank, water, filtration equipment, or other tank contents. Multidrug-resistant human *Salmonella* infections have been linked to contact with contaminated water from home aquariums containing tropical fish (92,93). A single case of *Plesiomonas shigelloides* infection in a Missouri infant was identified, and the organism was subsequently isolated from a babysitter's aquarium (94). A survey of tropical fish tanks in Missouri found that four (22%) of 18 tanks yielded *P. shigelloides* from three pet stores. During 2009–2011, approximately 200 *Salmonella enterica* serotype Typhimurium infections were linked to contact with African dwarf frogs, an aquatic amphibian, or their tank water or contents (C. Barton Behravesh, CDC, personal communication, 2011). Ill persons included those who reported such contact at carnivals, nursing homes, day cares, pet stores, and other retail stores (27). These findings have implications for risk for infection from aquatic exhibits (e.g., aquariums and aquatic touch tanks).

Sporadic Infections

Case-control studies also have associated sporadic infections (i.e., those not linked to an outbreak) with animals including reptiles and farm animals (82,95). For example, a study of sporadic *E. coli* O157:H7 infections in the United States determined that persons who became ill, especially children, were more likely than persons who did not become ill to have visited a farm with cows (96). Additional studies also documented an association between *E. coli* O157:H7 infection and visiting a farm (97) and living in a rural area (98). Studies of human cryptosporidiosis have documented contact with cattle and visiting farms as risk factors for infection (61,99,100).

Another study identified multiple factors associated with *Campylobacter* infection, including consumption of raw milk and contact with farm animals (101).

Additional Health Concerns

Although enteric diseases are the most commonly reported illnesses associated with animals in public settings, other health risks exist. For example, allergies can be associated with animal dander, scales, fur, feathers, urine, and saliva (102–108). Additional health concerns include injuries, exposure to rabies, and infections other than enteric diseases.

Injuries

Injuries associated with animals are a well-described and important problem. For example, dog bites are a substantial community problem for which specific guidelines have been written (109). Injuries associated with animals in public settings include bites, kicks, falls, scratches, stings, crushing of the hands or feet, and being pinned between the animal and a fixed object. These injuries have been associated with big cats (e.g., tigers), monkeys, and other domestic, wild, and zoo animals. Settings have included public stables, petting zoos, traveling photo opportunities, schools, children's parties, dog parks, and animal rides (M. Eidson, DVM, New York State Department of Health, personal communication, 2003; J.B. Bender, DVM, University of Minnesota, personal communication, 2003; M.T. Jay-Russell, DVM, California Department of Health, personal communication, 2003; G.L. Swinger, DVM, Tennessee Department of Health, personal communication, 2003). For example, a Kansas teenager was killed while posing for a photograph with a tiger being restrained by its handler at an animal sanctuary (110). In Texas, two high school students were bitten by a cottonmouth snake that was used in a science class after being misidentified as a nonvenomous species (W. Garvin, Caldwell Zoo, Texas, personal communication, 2008).

Exposure to Rabies

Persons who have contact with rabid mammals can be exposed to rabies virus through a bite or when mucous membranes or open wounds become contaminated with infected saliva or nervous tissue. Although no human rabies deaths caused by animal contact in public settings have been reported, multiple rabies exposures have occurred, requiring extensive public health investigation and medical follow-up. For example, thousands of persons have received rabies postexposure prophylaxis (PEP) after being exposed to rabid or potentially rabid animals, including bats, raccoons, cats, goats, bears,

sheep, horses, and dogs, at various venues: an urban public park (S. Slavinski, DVM, New York City Department of Health and Mental Hygiene, personal communication, 2010), a pet store in New Hampshire (111), a county fair in New York State (112), petting zoos in Iowa (113,114) and Texas (J.H. Wright, DVM, Texas Department of Health, personal communication, 2004), school and rodeo events in Wyoming (64), a horse show in Tennessee (J.R. Dunn, DVM, Tennessee Department of Health, personal communication, 2010), and summer camps in New York (115). Substantial public health and medical care challenges associated with potential mass rabies exposures include difficulty in identifying and contacting persons potentially at risk, correctly assessing exposure risks, and providing timely medical prophylaxis when indicated. Prompt assessment and treatment are critical to prevent this disease, which is usually fatal.

Other Infections

Multiple bacterial, viral, fungal, and parasitic infections have been associated with animal contact, and the infecting organisms are transmitted through various modes. Infections from animal bites are common and frequently require extensive treatment or hospitalization. Bacterial pathogens associated with animal bites include *Pasteurella* species, *Francisella tularensis* (116), *Staphylococcus* species, *Streptococcus* species, *Capnocytophaga canimorsus*, *Bartonella henselae* (cat-scratch disease), and *Streptobacillus moniliformis* (rat-bite fever). Certain monkey species (especially macaques) that are kept as pets or used in public exhibits can be infected with simian herpes B virus. Infected monkeys are often asymptomatic or have mild oral lesions yet human exposure through monkey bites or bodily fluids can result in fatal meningoencephalitis (117,118).

Skin contact with animals in public settings also is a public health concern. In 1995, a total of 15 cases of ringworm (club lamb fungus) caused by *Trichophyton* species and *Microsporium gypseum* were documented among owners and family members who exhibited lambs in Georgia (119). In 1986, ringworm in 23 persons and multiple animal species was traced to a *Microsporium canis* infection in a hand-reared zoo tiger cub (120). Orf virus infection (i.e., contagious ecthyma or sore mouth in sheep and goats) has occurred after contact with sheep at a public setting (121). Orf virus infection also has been described in goats and sheep at a children's petting zoo (122) and in a lamb used for an Easter photo opportunity (M. Eidson, DVM, New York State Department of Health, personal communication, 2003). Transmission of pox viruses in public settings also has been described. In the 1970s, after handling various species of infected exotic animals, a zoo

attendant experienced an extensive papular skin rash from a cowpox-like virus (123). Cowpox virus transmission from rats to humans was also documented among persons who had purchased the rats as pets or had contact with them at pet stores (124). In 2003, multiple cases of monkeypox occurred among persons who contacted infected prairie dogs either at a child-care center (125,126) or a pet store (J.J. Kazmierczak, DVM, Wisconsin Department of Health and Family Services, personal communication, 2004). Aquatic animals and their environment also have been associated with cutaneous infections (127). For example, *Mycobacterium marinum* infections have been described among persons owning or cleaning fish tanks (128,129).

Ectoparasites and endoparasites pose concerns when humans and exhibit animals interact. *Sarcoptes scabiei* is a skin mite that infests humans and animals, including swine, dogs, cats, foxes, cattle, and coyotes (130,131). Although human infestation from animal sources is usually self-limiting, skin irritation and itching might occur for multiple days and can be difficult to diagnose (131,132). Bites from avian mites have been reported in association with pet gerbils in school settings (133). Fleas from animals that bite humans increase the risk for infection or allergic reaction. In addition, fleas can carry a tapeworm species that can infect children who swallow the flea (134,135). Animal parasites also can infect humans who ingest materials contaminated with animal feces or who ingest or come into contact with contaminated soil. Parasite control through veterinary care and proper husbandry combined with hand washing reduces the risks associated with ectoparasites and endoparasites (136).

Tuberculosis is another disease concern for certain animal settings. In 1996, a total of 12 circus elephant handlers at an exotic animal farm in Illinois were infected with *Mycobacterium tuberculosis*; one handler had signs consistent with active disease after three elephants died of tuberculosis. Medical history and testing of the handlers indicated that the elephants had been a probable source of exposure for most of the human infections (137). During 1989–1991 at a zoo in Louisiana, seven animal handlers who were previously negative for tuberculosis tested positive after a *Mycobacterium bovis* outbreak in rhinoceroses and monkeys (138). Other instances of transmission of mycobacterial species from animals to animal care staff without known transmission to the public have also been documented (139–141). The U.S. Department of Agriculture (USDA) has developed guidelines regarding removal of tuberculosis-infected animals from public settings because of the risk for exposure to the public (142).

Zoonotic pathogens also can be transmitted by direct or indirect contact with reproductive fluids, aborted fetuses, or newborns from infected dams. Live-birthing exhibits, usually

involving livestock (e.g., cattle, pigs, goats, or sheep), are popular at agricultural fairs. Although the public usually does not have direct contact with animals during birthing, newborns and their dams might be available for petting afterward. Q fever (*Coxiella burnetii*), leptospirosis, listeriosis, brucellosis, and chlamydiosis are serious zoonoses that can be acquired through contact with reproductive materials (143).

C. burnetii is a rickettsial organism that most frequently infects cattle, sheep, and goats. The disease can cause abortion in animals, but more frequently the infection is asymptomatic. During birthing, infected animals shed large numbers of organisms, which can become aerosolized. Most persons exposed to *C. burnetii* develop an asymptomatic infection, but clinical illness can range from an acute influenza-like illness to life-threatening endocarditis. A Q fever outbreak involving 95 confirmed cases and 41 hospitalizations was linked to goats and sheep giving birth at petting zoos in indoor shopping malls (144). Indoor-birthing exhibits might pose an increased risk for Q fever transmission because of inadequate ventilation.

Chlamydia psittaci infections cause respiratory disease and are usually acquired from psittacine birds (145). For example, an outbreak of *C. psittaci* pneumonia occurred among the staff members at Copenhagen Zoological Garden (146). On rare occasions, chlamydial infections acquired from sheep, goats, and birds result in reproductive problems in women (145,147,148).

Transmission of influenza viruses between humans and animals has implications for animals in public settings. Cases and clusters of human infection with swine influenza viruses have been reported sporadically since the 1970s (149,150); several of these cases have been acquired from swine at agricultural fairs (151–153). Conversely, transmission of human influenza viruses to swine also has been documented (154). For example, in 2009, an H1N1 influenza virus strain emerged, causing a pandemic among humans with sporadic transmission from humans to swine (155).

Recommendations

Guidelines from multiple organizations were used to create the recommendations in this report (156–158). Although no federal U.S. laws address the risk for transmission of pathogens at venues where the public has contact with animals, some states have such laws (64,67,159–161). For example, in 2005, North Carolina enacted legislation requiring persons displaying animals for public contact at agricultural fairs to obtain a permit from the North Carolina Department of Agriculture and Consumer Services (<http://www.ncga.state>).

nc.us/enactedlegislation/statutes/pdf/bysection/chapter_106/gs_106-520.3a.pdf).

Certain federal agencies and associations in the United States have developed standards, recommendations, and guidelines for reducing risks associated with animal contact by the public in zoologic parks. The Association of Zoos and Aquariums has accreditation standards for reducing risk for animal contact with the public in zoologic parks (162). In accordance with the Animal Welfare Act, USDA licenses and inspects certain animal exhibits. These inspections primarily address humane treatment but also impact the health of the animal and safety of the public. In 2001, CDC issued guidelines to reduce the risk for infection with enteric pathogens associated with farm visits (66). CDC also has issued recommendations for preventing transmission of *Salmonella* from reptiles, amphibians, and live poultry to humans (27,77,78,86,163,164). The Association for Professionals in Infection Control and Epidemiology Inc. (APIC) and the Animal-Assisted Interventions Working Group (AAI) have developed guidelines to address risks associated with the use of animals in health-care settings (2,6). NASPHV has developed a compendium of measures to reduce risks for human exposure to *C. psittaci* and rabies virus (145,165).

Studies in some localities have suggested that implementation of these recommendations could be improved (60,166,167). Stakeholders should strive to facilitate comprehensive implementation of the following recommendations.

Recommendations for Local, State, and Federal Agencies

Communication and cooperation among human and animal health agencies should be enhanced and include veterinarians and cooperative extension offices. Additional research should be conducted regarding the risk factors and effective prevention and control methods for health issues associated with animal contact.

To enhance uptake of these recommendations, agencies should take the following steps:

- Disseminate this report to cooperative extension personnel, venue operators, and others associated with managing animals in public settings. States should strive to develop a complete list of public animal contact venues to facilitate dissemination of recommendations.
- Disseminate educational and training materials to venue operators and other stakeholders. Material formats could include PowerPoint slide presentations, videos, and written guidelines (164).
- Encourage or require oversight to ensure compliance with recommendations at animal contact venues.

To evaluate and improve these recommendations, surveillance for human health issues associated with animal contact should be enhanced. Agencies should take the following steps:

- Conduct thorough epidemiologic investigations of outbreaks.
- Include questions on disease report forms and outbreak investigation questionnaires about exposure to animals, animal environments, and animal products and feed.
- Follow appropriate protocols for sampling and testing of humans, animals, and the environment, including molecular subtyping of pathogen isolates.
- Report outbreaks to state health departments.
- Local and state public health departments should also report all outbreaks of enteric infections resulting from animal contact to CDC through the National Outbreak Reporting System (NORS) (<http://www.cdc.gov/outbreaknet/nors>).

Recommendations for Education

Education is essential to reduce risks associated with animal contact in public settings. Experience from outbreaks suggests that visitors knowledgeable about potential risks are less likely to become ill (14). Even in well-designed venues with operators who are aware of the risks for disease, outbreaks can occur when visitors do not understand risks and therefore are less likely to apply disease-prevention measures.

Venue operators should take the following steps:

- Become knowledgeable about the risks for disease and injury associated with animals and be able to explain risk-reduction measures to staff members and visitors.
- Become familiar with and implement the recommendations in this compendium.
- Consult with veterinarians, state and local agencies, and cooperative extension personnel on implementation of the recommendations.
- Develop or obtain training and educational materials and train staff members.
- Ensure that visitors receive educational messages before they enter the exhibit, including information that animals can cause injuries or carry organisms that can cause serious illness (Appendices A and B).
- Provide information in a simple and easy-to-understand format that is age- and language-appropriate.
- Provide information in multiple formats (e.g., signs, stickers, handouts, and verbal information).
- Provide information to persons arranging school field trips or classroom exhibits so that they can educate participants and parents before the visit.

Venue staff members should take the following steps:

- Become knowledgeable about the risks for disease and injury associated with animals and be able to explain risk-reduction recommendations to visitors.
- Ensure that visitors receive educational messages regarding risks and prevention measures.
- Encourage compliance by the public with risk-reduction recommendations, especially compliance with hand-washing procedures (Appendix C) as visitors exit animal areas.
- Comply with local and state requirements for reporting animal bites or other injuries.

Recommendations for Managing Public-Animal Contact

The recommendations in this report were developed for settings in which direct animal contact is encouraged (e.g., petting zoos and aquatic touch tanks) and in which animal contact is possible (e.g., county fairs). They should be tailored to specific settings and incorporated into guidelines and regulations developed at the state or local level. Contact with animals should occur in settings where measures are in place to reduce the potential for injuries or disease transmission. Incidents or problems should be investigated, documented, and reported.

Facility Design

The design of facilities and animal pens should minimize the risk associated with animal contact (Figure), including limiting direct contact with manure and encouraging hand washing (Appendix C). The design of facilities or contact settings might include double barriers to prevent contact with animals or contaminated surfaces except for in specified animal interaction areas. Previous outbreaks have revealed that temporary exhibits are often not designed appropriately. Common problems include inadequate barriers, floors and other surfaces that are difficult to keep clean and disinfect, insufficient plumbing, lack of signs regarding risk and prevention measures, and inadequate hand-washing facilities (13, 14, 19, 33, 36). Specific guidelines might be necessary for certain settings, such as schools (Appendix D).

Recommendations for cleaning and disinfection should be tailored to the specific situation. All surfaces should be cleaned thoroughly to remove organic matter before disinfection. A 1:32 dilution of household bleach (e.g., one-half cup bleach per gallon of water) is needed for basic disinfection. Quaternary ammonium compounds (e.g., Roccal or Zephiran) also can be used per the manufacturer label. For disinfection when a particular organism has been identified, additional guidance is available (<http://www.cfsph.iastate.edu/disinfection>). Most compounds require >10 minutes of contact time with a contaminated surface.

Venues should be divided into three types of areas: nonanimal areas (where animals are not permitted, with the exception of service animals), transition areas (located at entrances and exits to animal areas), and animal areas (where animal contact is possible or encouraged) (Figure).

Nonanimal Areas

- Do not permit animals, except service animals, in nonanimal areas.
- Prepare, serve, and consume food and beverages only in nonanimal areas.
- Provide hand-washing facilities and display hand-washing signs where food or beverages are served (Appendix C).

Transition Areas Between Nonanimal and Animal Areas

Establishing transition areas through which visitors pass when entering and exiting animal areas is critical. For areas where animal contact is encouraged, a one-way flow of visitors is preferred, with separate entrance and exit points. The transition areas should be designated as clearly as possible, even if they are conceptual rather than physical (Figure).

Entrance transition areas should be designed to facilitate education:

- Post signs or otherwise notify visitors that they are entering an animal area and that there are risks associated with animal contact (Appendix B).
- Instruct visitors not to eat, drink, smoke, place their hands in their mouth, or use bottles or pacifiers while in the animal area.
- Establish storage or holding areas for strollers and related items (e.g., wagons and diaper bags).
- Control visitor traffic to prevent overcrowding.

Exit transition areas should be designed to facilitate hand washing:

- Post signs or otherwise instruct visitors to wash their hands when leaving the animal area.
- Provide accessible hand-washing stations for all visitors, including children and persons with disabilities (Figure).
- Position venue staff members near exits to encourage compliance with proper hand washing.

Animal Areas

- Do not allow food and beverages in animal areas.
- Do not allow toys, pacifiers, spill-proof cups, baby bottles, strollers or similar items in animal areas.
- Prohibit smoking and other tobacco product use in animal areas.
- Supervise children closely to discourage hand-to-mouth activities (e.g., nail-biting and thumb-sucking), contact with manure, and contact with soiled bedding. Children should

FIGURE. Examples of designs for animal contact settings, including clearly designated animal areas, nonanimal areas, and transition areas with hand-washing stations and signs

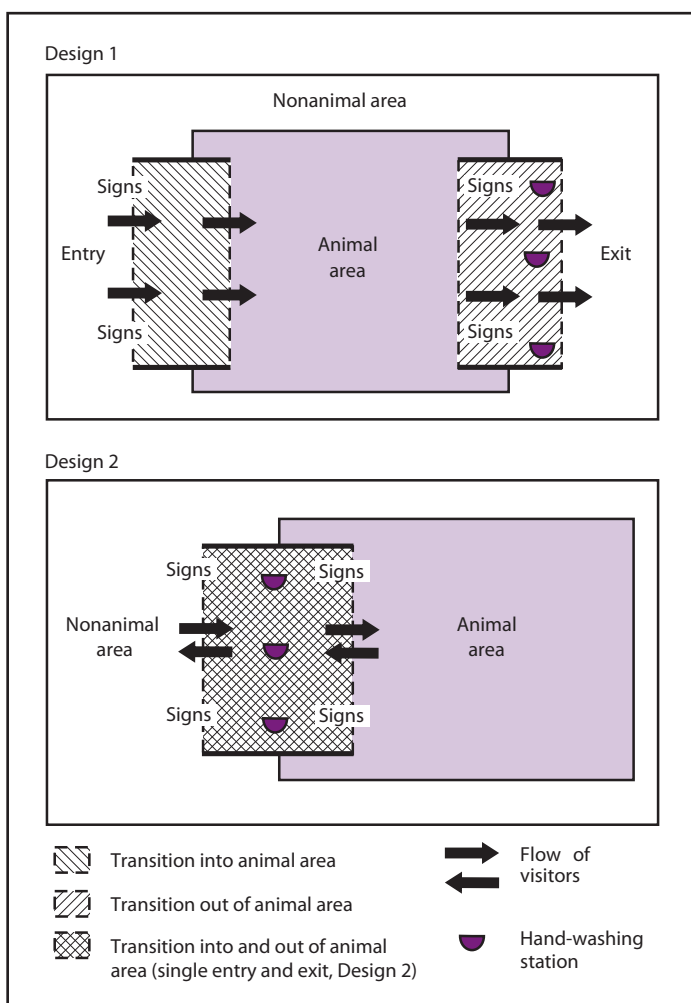

not be allowed to sit or play on the ground in animal areas. If hands become soiled, supervise hand washing immediately.

- Ensure that regular animal feed and water are not accessible to the public.
- Allow the public to feed animals only if contact with animals is controlled (e.g., with barriers).
- Do not provide animal feed in containers that can be eaten by humans (e.g., ice cream cones) to decrease the risk for children eating food that has come into contact with animals.
- Promptly remove manure and soiled animal bedding from animal areas.
- Assign trained staff members to encourage appropriate human-animal interactions, to identify and reduce potential risks for patrons, and process reports of injuries and exposures.

- Store animal waste and specific tools for waste removal (e.g., shovels and pitchforks) in designated areas that are restricted from public access.
- Avoid transporting manure and soiled bedding through nonanimal areas or transition areas. If this is unavoidable, take precautions to prevent spillage.
- Where feasible, disinfect animal areas (e.g., flooring and railings) at least once daily.
- Provide adequate ventilation both for animals (168) and humans.
- Minimize the use of animal areas for public activities (e.g., weddings and dances). If areas previously used for animals must be used for public events, the areas should be cleaned and disinfected, particularly if food and beverages are served.
- For birds in bird encounter exhibits, refer to the psittacosis compendium (145) for recommendations regarding disease prevention and control.
- Visitors to aquatic touch tank exhibits who have open wounds should be advised not to participate. Hand-washing stations should be provided.
- When using animals or animal products (e.g., animal pelts, animal waste, and owl pellets) for educational purposes, only use them in designated animal areas. Animals and animal products should not be brought into school cafeterias and other areas where food and beverages are prepared, served, or consumed.
- When animals are in school classrooms, specific areas must be designated for animal contact (Appendix D). Designated animal areas must be thoroughly cleaned after use. Parents should be informed of the benefits and potential risks associated with animals in school classrooms.

Animal Care and Management

The risk for disease or injury from animal contact can be reduced by carefully managing the specific animals used. The following recommendations should be considered for management of animals in contact with the public.

- **Animal care:** Monitor animals daily for signs of illness and ensure that animals receive appropriate veterinary care. Ill animals, animals known to be infected with a zoonotic pathogen, and animals from herds with a recent history of abortion, diarrhea, or respiratory disease should not be exhibited. To decrease shedding of pathogens, animals should be housed to minimize stress and overcrowding.
- **Veterinary care:** Retain and use the services of a licensed veterinarian. Preventive care, including vaccination and parasite control, appropriate for the species should be provided. Certificates of veterinary inspection from an

accredited veterinarian should be up-to-date according to local or state requirements for animals in public settings. A herd or flock inspection is a critical component of the health certificate process. Routine screening for diseases is not recommended, except for *C. psittaci* in bird encounter exhibits (145), tuberculosis in elephants (141) and primates, and Q fever in ruminants in birthing exhibits (169).

- **Rabies:** All animals should be housed to reduce potential exposure to wild animal rabies reservoirs. Mammals should also be up-to-date on rabies vaccinations according to current recommendations (165). These steps are particularly critical in areas where rabies is endemic and in venues where animal contact is encouraged (e.g., petting zoos). Because of the extended incubation period for rabies, unvaccinated mammals should be vaccinated at least 1 month before they have contact with the public. If no licensed rabies vaccine exists for a particular species (e.g., goats, swine, llamas, and camels) that is used in a setting where public contact occurs, consultation with a veterinarian regarding off-label use of rabies vaccine is recommended. Use of off-label vaccine does not provide the same level of assurance as vaccine labeled for use in a particular species; however, off-label use of vaccine might provide protection for certain animals and thus decrease the probability of rabies transmission (165). Vaccinating slaughter-class animals before displaying them at fairs might not be feasible because of the vaccine withdrawal period that occurs as a result of antibiotics used as preservatives in certain vaccines. Mammals that are too young to be vaccinated should be used in exhibit settings only if additional restrictive measures are available to reduce risks (e.g., using only animals that were born to vaccinated mothers and housed to avoid rabies exposure). In animal contact settings, rabies testing should be considered for animals that die suddenly in addition to other diagnostic considerations.
- **Dangerous animals:** Because of their strength, unpredictability, venom, or the pathogens that they might carry, certain domestic, exotic, or wild animals should be prohibited in exhibit settings where a reasonable possibility of animal contact exists. Species of primary concern include nonhuman primates (e.g., monkeys and apes) and certain carnivores (e.g., lions, tigers, ocelots, wolves and wolf hybrids, and bears). In addition, rabies-reservoir species (e.g., bats, raccoons, skunks, foxes, and coyotes) should not be used for direct contact.
- **Animal births:** Ensure that the public has no contact with newly born animals or birthing by-products (e.g., the placenta). In live-birth exhibits, the environment should be thoroughly cleaned after each birth, and all waste

products should be properly discarded. Holding such events outside or in well-ventilated areas is preferable.

Additional Recommendations

- **Populations at high risk:** Children aged <5 years are at particularly high risk for serious infection. Other groups at increased risk include persons with waning immunity (e.g., older adults) and persons who are mentally impaired, pregnant, or immunocompromised (e.g., persons with human immunodeficiency virus/acquired immunodeficiency syndrome, without a functioning spleen, or receiving immunosuppressive therapy). Persons at high risk for infection should take heightened precautions at animal exhibits. In addition to thorough and frequent hand washing, heightened precautions could include avoiding contact with animals and their environment (e.g., pens, bedding, and manure). Animals of particular concern for transmitting enteric diseases include young ruminants, live poultry, reptiles, amphibians, and ill animals.
- **Consumption of unpasteurized products:** Prohibit the consumption of unpasteurized or raw dairy products (e.g., milk, cheese, and yogurt) and unpasteurized apple cider or juices.
- **Drinking water:** Local public health authorities should inspect drinking water systems before use. Only potable water should be used for consumption by animals and humans. Back-flow prevention devices should be installed between outlets in livestock areas and water lines supplying other areas on the grounds. If the water supply is from a well, adequate distance should be maintained from possible sources of contamination (e.g., animal-holding areas and manure piles). Maps of the water distribution system should be available for use in identifying potential or actual problems. The use of outdoor hoses should be minimized, and hoses should not be left on the ground. Hoses that are accessible to the public should be labeled “water not for human consumption.” Operators and managers of settings in which treated municipal water is not available should ensure that a safe water supply (e.g., bottled water) is available.

References

1. Steinmuller N, Demma L, Bender JB, Eidson M, Angulo FJ. Outbreaks of enteric disease associated with animal contact: not just a foodborne problem anymore. *Clin Infect Dis* 2006;43:1596–602.
2. Duncan SL. APIC State-of-the-art report: the implications of service animals in health care settings. *Am J Infect Control* 2000;28:170–80.

3. Schulster L, Chinn R, Arduino M, et al. Guidelines for environmental infection control in health-care facilities: recommendations of CDC and the Healthcare Infection Control Practices Advisory Committee (HICPAC). Chicago, IL: American Society for Healthcare Engineering/American Hospital Association, 2004. Available at http://www.cdc.gov/ncidod/dhqp/pdf/guidelines/enviro_guide_03.pdf.
4. Guay DR. Pet-assisted therapy in the nursing home setting: potential for zoonosis. *Am J Infect Control* 2001;29:178–86.
5. Scheffel JM, Elchos BL, Cherry B, et al. Compendium of veterinary standard precautions for zoonotic disease prevention in veterinary personnel: national association of state public health veterinarians veterinary infection control committee 2010. *J Am Vet Med Assoc* 2010;237:1403–22.
6. Lefebvre SL, Golab GC, Christensen E, et al. Guidelines for animal-assisted interventions in health care facilities. *Am J Infect Control* 2008;36:78–85.
7. LeJeune JT, Davis MA. Outbreaks of zoonotic enteric disease associated with animal exhibits. *J Am Vet Med Assoc* 2004;224:1440–5.
8. Chappell CL, Okhuysen PC, Sterling CR, DuPont HL. Cryptosporidium parvum: intensity of infection and oocyst excretion patterns in healthy volunteers. *J Infect Dis* 1996;173:232–6.
9. Bell BP, Goldoft M, Griffin PM, et al. A multistate outbreak of *Escherichia coli* O157:H7-associated bloody diarrhea and hemolytic uremic syndrome from hamburgers: the Washington experience. *JAMA* 1994;272:1349–53.
10. Tilden J, Jr, Young W, McNamara AM, et al. A new route of transmission for *Escherichia coli*: infection from dry fermented salami. *Am J Public Health* 1996;86:1142–5.
11. Shukla R, Slack R, George A, Cheasty T, Rowe B, Scutter J. *Escherichia coli* O157 infection associated with a farm visitor centre. *Commun Dis Rep CDR Rev* 1995;5:86–90.
12. Sayers G, Dillon M, Connolly E, et al. Cryptosporidiosis in children who visited an open farm. *Commun Dis Rep CDR Rev* 1996;6:R140–4.
13. CDC. Outbreaks of *Escherichia coli* O157:H7 associated with petting zoos—North Carolina, Florida, and Arizona, 2004 and 2005. *MMWR* 2005;54:1277–80.
14. Goode B, O'Reilly C, Dunn J, et al. Outbreak of *Escherichia coli* O157:H7 infections after petting zoo visits, North Carolina state fair, October–November 2004. *Arch Pediatr Adolesc Med* 2009;163:42–8.
15. Crump JA, Sulka AC, Langer AJ, et al. An outbreak of *Escherichia coli* O157:H7 infections among visitors to a dairy farm. *N Engl J Med* 2002;347:555–60.
16. David ST, MacDougall L, Louie K, et al. Petting zoo-associated *Escherichia coli* O157:H7—secondary transmission, asymptomatic infection, and prolonged shedding in the classroom. *Can Commun Dis Rep* 2004;30:173–80.
17. Durso LM, Reynolds K, Bauer N Jr, Keen JE. Shiga-toxigenic *Escherichia coli* O157:H7 infections among livestock exhibitors and visitors at a Texas county fair. *Vector Borne Zoonotic Dis* 2005;5:193–201.
18. Evans M, Gardner D. Cryptosporidiosis outbreak associated with an educational farm holiday. *Commun Dis Rep CDR Rev* 1996;1996:50–1.
19. Friedman CR, Torigian C, Shillam PJ, et al. An outbreak of salmonellosis among children attending a reptile exhibit at a zoo. *J Pediatr* 1998;132:802–7.
20. Kiang KM, Scheffel JM, Leano FT, et al. Recurrent outbreaks of cryptosporidiosis associated with calves among students at an educational farm program, Minnesota, 2003. *Epidemiol Infect* 2006;134:878–86.
21. Pritchard GC, Willshaw GA, Bailey JR, Carson T, Cheasty T. Verocytotoxin-producing *Escherichia coli* O157 on a farm open to the public: outbreak investigation and longitudinal bacteriological study. *Vet Rec* 2000;147:259–64.
22. Smith KE, Stenzel SA, Bender JB, et al. Outbreaks of enteric infections caused by multiple pathogens associated with calves at a farm day camp. *Pediatr Infect Dis J* 2004;23:1098–104.
23. Warshawsky B, Gutmanis I, Henry B, et al. An outbreak of *Escherichia coli* O157:H7 related to animal contact at a petting zoo. *Can J Infect Dis* 2002;13:175–81.
24. Chapman PA, Cornell J, Green C. Infection with verocytotoxin-producing *Escherichia coli* O157 during a visit to an inner city open farm. *Epidemiol Infect* 2000;125:531–6.
25. CDC. Three outbreaks of salmonellosis associated with baby poultry from three hatcheries—United States, 2006. *MMWR* 2007;56:273–6.
26. Fuller CC, Jawahir SL, Leano FT, et al. A multi-state *Salmonella* Typhimurium outbreak associated with frozen vacuum-packed rodents used to feed snakes. *Zoonoses Public Health* 2008;55:481–7.
27. CDC. Multistate outbreak of human *Salmonella* Typhimurium infections associated with aquatic frogs—United States, 2009. *MMWR* 2010;58:1433–6.
28. Keen JE, Elder RO. Isolation of Shiga-toxigenic *Escherichia coli* O157 from hide surfaces and the oral cavity of finished beef feedlot cattle. *J Am Vet Med Assoc* 2002;220:756–63.
29. Keene W, deBroekert M, Gillette K. A large *Escherichia coli* O157:H7 outbreak at a county fair [Abstract 55:77]. In: Programs and abstracts of the International Conference on Emerging Infectious Diseases, Atlanta, GA; February 29–March 3, 2004.
30. Croft DR, Archer J, Roberts C, et al. Outbreak of *Escherichia coli* O157:H7 infections associated with a pancake breakfast served in a stock pavilion with contaminated livestock bedding—Wisconsin, 2001. In: Programs and abstracts of the 51st Annual Epidemic Intelligence Conference, Atlanta, GA; April 22–26, 2002.
31. Doorduyn Y, Van Den Brandhof WE, Van Duynhoven YT, Wannet WJ, Van Pelt W. Risk factors for *Salmonella* Enteritidis and Typhimurium (DT104 and non-DT104) infections in The Netherlands: predominant roles for raw eggs in Enteritidis and sandboxes in Typhimurium infections. *Epidemiol Infect* 2006;134:617–26.
32. Varma JK, Greene KD, Reller ME, et al. An outbreak of *Escherichia coli* O157 infection following exposure to a contaminated building. *JAMA* 2003;290:2709–12.
33. Payne CJ, Petrovic M, Roberts RJ, et al. Vero cytotoxin-producing *Escherichia coli* O157 gastroenteritis in farm visitors, North Wales. *Emerg Infect Dis* 2003;9:526–30.
34. Djuretic T, Wall PG, Nichols G. General outbreaks of infectious intestinal disease associated with milk and dairy products in England and Wales: 1992 to 1996. *Commun Dis Rep CDR Rev* 1997;7:41–5.
35. Korlath JA, Osterholm MT, Judy LA, Forfang JC, Robinson RA. A point-source outbreak of campylobacteriosis associated with consumption of raw milk. *J Infect Dis* 1985;152:592–6.
36. Sharp JC. Infections associated with milk and dairy products in Europe and North America, 1980–85. *Bull World Health Organ* 1987;65:397–406.

37. DeSchrijver K, Buvens G, Possé B, et al. Outbreak of verocytotoxin-producing *E. coli* 145 and O26 infections associated with the consumption of ice cream produced at a farm, Belgium, 2007. *Eurosurveillance* 2008;13:1–2.
38. Anonymous. Waterborne outbreak of gastroenteritis associated with a contaminated municipal water supply, Walkerton, Ontario, May–June 2000. *Can Commun Dis Rep* 2000;26:170–3.
39. Bopp DJ, Sauders BD, Waring AL, et al. Detection, isolation, and molecular subtyping of *Escherichia coli* O157:H7 and *Campylobacter jejuni* associated with a large waterborne outbreak. *J Clin Microbiol* 2003;41:174–80.
40. CDC. Outbreak of *Escherichia coli* O157:H7 and *Campylobacter* among attendees of the Washington County Fair—New York, 1999. *MMWR* 1999;48:803–5.
41. Keen JE, Wittum TE, Dunn JR, Bono JL, Durso LM. Shiga-toxicogenic *Escherichia coli* O157 in agricultural fair livestock, United States. *Emerg Infect Dis* 2006;12:780–6.
42. Kudva IT, Blanch K, Hovde CJ. Analysis of *Escherichia coli* O157:H7 survival in ovine or bovine manure and manure slurry. *Appl Environ Microbiol* 1998;64:3166–74.
43. LeJeune JT, Besser TE, Hancock DD. Cattle water troughs as reservoirs of *Escherichia coli* O157. *Appl Environ Microbiol* 2001;67:3053–7.
44. Maule A. Survival of verocytotoxigenic *Escherichia coli* O157 in soil, water, and on surfaces. *J Appl Microbiol* 2000;29:S71–8.
45. Rahn K, Renwick SA, Johnson RP, et al. Persistence of *Escherichia coli* O157:H7 in dairy cattle and the dairy farm environment. *Epidemiol Infect* 1997;119:251–9.
46. Randall LP, Wray C, Davies RH. Survival of verocytotoxin-producing *Escherichia coli* O157 under simulated farm conditions. *Vet Rec* 1999;145:500–1.
47. Béraud R, Huneault L, Bernier D, et al. Comparison of the selection of antimicrobial resistance in fecal *Escherichia coli* during enrofloxacin administration with a local drug delivery system or with intramuscular injections in a swine model. *Can J Vet Res* 2008;72:311–9.
48. Corrier DE, Purdy CW, DeLoach JR. Effects of marketing stress on fecal excretion of *Salmonella* spp in feeder calves. *Am J Vet Res* 1990;51:866–9.
49. Hurd HS, McKean JD, Griffith RW, Wesley IV, Rostagno MH. *Salmonella enterica* infections in market swine with and without transport and holding. *Appl Environ Microbiol* 2002;68:2376–81.
50. Hurd HS, McKean JD, Wesley IV, Karriker LA. The effect of lairage on *Salmonella* isolation from market swine. *J Food Prot* 2001;64:939–44.
51. Isaacson RE, Firkins LD, Weigel RM, Zuckermann FA, DiPietro JA. Effect of transportation and feed withdrawal on shedding of *Salmonella* Typhimurium among experimentally infected pigs. *Am J Vet Res* 1999;60:1155–8.
52. Marg H, Scholz HC, Arnold T, Rosler U, Hensel A. Influence of long-time transportation stress on re-activation of *Salmonella typhimurium* DT104 in experimentally infected pigs. *Berl Munch Tierarztl Wochenschr* 2001;114:385–8.
53. US Department of Agriculture. *Escherichia coli* O157 in the United States feedlots. Fort Collins, CO: US Department of Agriculture, Centers for Epidemiology and Animal Health, Animal and Plant Health Inspection Service, Veterinary Services; 2001. Available at <http://nahms.aphis.usda.gov/feedlot/feedlot99/FD99ecoli.pdf>.
54. Williams LP, Newell KW. *Salmonella* excretion in joy-riding pigs. *Am J Public Health Nations Health* 1970;60:926–9.
55. Webb CR. Investigating the potential spread of infectious diseases of sheep via agricultural shows in Great Britain. *Epidemiol Infect* 2006;134:31–40.
56. Garber LP, Wells SJ, Hancock DD, et al. Risk factors for fecal shedding of *Escherichia coli* O157:H7 in dairy calves. *J Am Vet Med Assoc* 1995;207:46–9.
57. Hancock DD, Besser TE, Kinsel ML, Tarr PI, Rice DH, Paros MG. The prevalence of *Escherichia coli* O157:H7 in dairy and beef cattle in Washington state. *Epidemiol Infect* 1994;113:199–207.
58. Hancock DD, Besser TE, Rice DH, Herriott DE, Tarr PI. A longitudinal study of *Escherichia coli* O157 in fourteen cattle herds. *Epidemiol Infect* 1997;118:193–5.
59. US Department of Agriculture. *Salmonella* in United States feedlots. Fort Collins, CO: US Department of Agriculture, Centers for Epidemiology and Animal Health, Animal and Plant Health Inspection Service, Veterinary Services; 2001. Available at <http://nahms.aphis.usda.gov/feedlot/feedlot99/FD99ecoli.pdf>.
60. McMillian M, Dunn JR, Keen JE, Brady KL, Jones TF. Risk behaviors for disease transmission among petting zoo attendees. *JAVMA* 2007;231:1036–8.
61. Soderlund D, Smith K, Bender J, Hedberg C. An epidemiologic investigation of cryptosporidiosis in Minnesota. In: Programs and abstracts of the International Conference on Emerging Infectious Diseases, Atlanta, GA; July 16–19, 2000.
62. Belongia EA, Chyou PH, Greenlee RT, Perez-Perez G, Bibb WF, DeVries EO. Diarrhea incidence and farm-related risk factors for *Escherichia coli* O157:H7 and *Campylobacter jejuni* antibodies among rural children. *J Infect Dis* 2003;187:1460–8.
63. Keen JE, Durso LM, Meehan TP. Isolation of *Salmonella enterica* and Shiga-toxicogenic *Escherichia coli* O157 from feces of animals in public contact areas of United States zoological parks. *Appl Environ Microbiol* 2007;73:362–5.
64. Bender JB, Shulman SA. Reports of zoonotic disease outbreaks associated with animal exhibits and availability of recommendations for preventing zoonotic disease transmission from animals to people in such settings. *J Am Vet Med Assoc* 2004;224:1105–9.
65. Crump JA, Braden CR, Dey ME, et al. Outbreaks of *Escherichia coli* O157 infections at multiple county agricultural fairs: a hazard of mixing cattle, concession stands and children. *Epidemiol Infect* 2003;131:1055–62.
66. CDC. Outbreaks of *Escherichia coli* O157:H7 infections among children associated with farm visits—Pennsylvania and Washington, 2000. *MMWR* 2001;50:293–7.
67. Chertow D. Outbreak of *Escherichia coli* O157:H7 related to direct and indirect animal contact in petting zoos—Florida, 2005. In: Programs and abstracts of the 55th Annual Epidemic Intelligence Service Conference, Atlanta, GA; April 24–28, 2006.
68. North Carolina Department of Health and Human Services. *E. coli* outbreak. Raleigh, NC: North Carolina Department of Health and Human Services; 2004. Available at <http://www.epi.state.nc.us/epi/gcdc/ecoli/EColiReportFinal062905.pdf>.
69. Durso LM, Keen JE, Bauer N Jr. Assessment of three remediation strategies for reduction of Shiga-toxinogenic *Escherichia coli* (STEC) O157 in naturally contaminated soil. In: Abstracts of the Institute of Food Technology Annual Meeting & Food Expo, Chicago, IL; July 26–30, 2007.

70. Coronado F, Johnson G, Kacica M, et al. A large outbreak of cryptosporidiosis and *Escherichia coli* O111 infections associated with consumption of unpasteurized apple cider—New York, 2004. In: Programs and abstracts of the 54th Annual Epidemic Intelligence Service Conference, Atlanta, GA; April 11–15, 2005.
71. CDC. Outbreak of shiga toxin-producing *Escherichia coli* O157 infection associated with a day camp petting zoo—Pinellas county, Florida, May–June 2007. MMWR 2009;58:46–8.
72. Smith KE, Anderson F, Medus C, Leano F, Adams J. Outbreaks of salmonellosis at elementary schools associated with dissection of owl pellets. Vector Borne Zoonotic Dis 2005;5:133–6.
73. Lamm SH, Taylor A, Gangarosa EJ, et al. Turtle-associated salmonellosis. Am J Epidemiol 1972;95:511–7.
74. Swanson SJ, Snider C, Braden CR, et al. Multidrug-resistant *Salmonella enterica* serotype Typhimurium associated with pet rodents. N Engl J Med 2007;356:21–8.
75. CDC. Salmonella hadar associated with pet ducklings—Connecticut, Maryland, and Pennsylvania, 1991. MMWR 1992;41:185–7.
76. CDC. Salmonella serotype Montevideo infections associated with chicks—Idaho, Washington, and Oregon, spring 1995 and 1996. MMWR 1997;46:237–9.
77. CDC. Salmonellosis associated with chicks and ducklings—Michigan and Missouri, spring 1999. MMWR 2000;49:297–9.
78. CDC. Multistate outbreaks of Salmonella infections associated with live poultry—United States, 2007. MMWR 2009;58:25–9.
79. CDC. Turtle-associated salmonellosis in humans—United States, 2006–2007. MMWR 2007;56:649–52.
80. CDC. Multistate outbreak of human Salmonella infections associated with exposure to turtles—United States, 2007–2008. MMWR 2008;57:69–72.
81. Bartlett K, Trust T, Lior H. Small pet aquarium frogs as a source of Salmonella. Appl Environ Microbiol 1977;33:1026–9.
82. Mermin J, Hutwagner L, Vugia D, et al. Reptiles, amphibians, and human Salmonella infection: a population-based, case-control study. Clin Infect Dis 2004;38(suppl 3):253–61.
83. Younus M, Wilkins M, Davies H, et al. The role of exposures to animals and other risk factors in sporadic, non-typhoidal Salmonella infections in Michigan children. Zoonoses Public Health 2010;e1–7. Available at <http://onlinelibrary.wiley.com/doi/10.1111/j.1863-2378.2010.01324.x/abstract>.
84. Harris J, Neil K, Behraves C, Sotir M, Angulo F. Recent multistate outbreaks of human Salmonella infections acquired from turtles: a continuing public health challenge. Clin Infect Dis 2010;50:554–9.
85. Harris J, Bergmire-Sweat D, Schlegel J, et al. Multistate outbreak of Salmonella infections associated with small turtle exposure, 2007–2008. Pediatrics 2009;124:138–94.
86. CDC. Multistate outbreak of human *Salmonella* Typhimurium infections associated with pet turtle exposure—United States, 2008. MMWR 2010;59:191–6.
87. Behraves C, Ferraro A, Deasy M, et al. Human Salmonella infections linked to contaminated dry dog and cat food, 2006–2008. Pediatrics 2010;126:477–83.
88. Laboratory Centre for Disease Control, Public Health Agency of Canada. Human health risk from exposure to natural dog treats. Can Commun Dis Rep 2000;26:41–2.
89. Clark C, Cunningham J, Ahmed R, et al. Characterization of Salmonella associated with pig ear dog treats in Canada. J Clin Microbiol 2001;39:3962–8.
90. Pitout JD, Reisbig MD, Mulvey M, et al. Association between handling of pet treats and infection with *Salmonella enterica* serotype Newport expressing the AmpC β -lactamase, CMY-2. J Clin Microbiol 2003;41:4578–82.
91. CDC. Human salmonellosis associated with animal-derived pet treats—United States and Canada, 2005. MMWR 2006;55:702–5.
92. Levings RS, Lightfoot D, Hall RM, Djordjevic SP. Aquariums as reservoirs for multidrug-resistant *Salmonella* Paratyphi B. Emerg Infect Dis 2005;12:507–10.
93. Musto J, Kirk M, Lightfoot D, et al. Multi-drug resistant *Salmonella* Java infections acquired from tropical fish aquariums, Australia, 2003–04. Commun Dis Intell 2006;30:222–7.
94. CDC. Aquarium-associated *Plesiomonas shigelloides* infection—Missouri. MMWR 1989;38:617–9.
95. Voetsch A, Kennedy M, Keene W, et al. Risk factors for sporadic Shiga toxin-producing *Escherichia coli* O157 infections in FoodNet sites, 1999–2000. Epidemiol Infect 2007;135:99–1000.
96. Kassenborg HD, Hedberg CW, Hoekstra M, et al. Farm visits and undercooked hamburgers as major risk factors for sporadic *Escherichia coli* O157:H7 infection: data from a case-control study in 5 FoodNet sites. Clin Infect Dis 2004;38:271–S8.
97. O'Brien SJ, Adak GK, Gilham C. Contact with farming environment as a major risk factor for Shiga toxin (Vero cytotoxin)-producing *Escherichia coli* O157 infection in humans. Emerg Infect Dis 2001;7:1049–51.
98. Haack JP, Jelacic S, Besser TE, et al. *Escherichia coli* O157 exposure in Wyoming and Seattle: serologic evidence of rural risk. Emerg Infect Dis 2003;9:1226–31.
99. Hunter PR, Hughes S, Woodhouse S, et al. Sporadic cryptosporidiosis case-control study with genotyping. Emerg Infect Dis 2004;10:1241–9.
100. Roy SL, DeLong SM, Stenzel SA, et al. Risk factors for sporadic cryptosporidiosis among immunocompetent persons in the United States from 1999 to 2001. J Clin Microbiol 2004;42:2944–51.
101. Friedman CR, Hoekstra RM, Samuel M, et al. Risk factors for sporadic *Campylobacter* infection in the United States: a case-control study in FoodNet sites. Clin Infect Dis 2004;38:285–96.
102. Bardana EJ Jr. What characterizes allergic asthma? Ann Allergy 1992;68:371–3.
103. American Academy of Allergy Asthma and Immunology. Executive summary report, 1998. Milwaukee, WI: Task Force on Allergic Disorders; 1998.
104. Lincoln TA, Bolton NE, Garrett AS, Jr. Occupational allergy to animal dander and sera. J Occup Med 1974;16:465–9.
105. Kelso JM, Fox RW, Jones RT, Yunginger JW. Allergy to iguana. J Allergy Clin Immunol. 2000;106:369–72.
106. Levine EG, Manilov A, McAllister SC, Heymann WR. Iguana bite-induced hypersensitivity reaction. Arch Dermatol 2003;139:1658–9.
107. American Academy of Allergy Asthma and Immunology. Tips to remember: indoor allergens. Available at www.aaaai.org/patients/publicedmat/tips/indoorallergens.stm.
108. Fairley JA, Suchniak J, Paller AS. Hedgehog hives. Arch Dermatol 1999;135:561–3.
109. American Veterinary Medical Association TaskForce on Canine Aggression and Human-Canine Interactions. A community approach to dog bite Prevention. J Am Vet Med Assoc 2001;218:1732–49.
110. Siemaszko C. Tiger kills Kansas teen: mauled while posing for pic. New York Daily News. August 20, 2005.

111. CDC. Mass treatment of humans exposed to rabies—New Hampshire, 1994. *MMWR* 1995;44:484–6.
112. Chang HG, Eidson M, Noonan-Toly C, et al. Public health impact of reemergence of rabies, New York. *Emerg Infect Dis* 2002;8:909–13.
113. CDC. Public health response to a potentially rabid bear cub—Iowa, 1999. *MMWR* 1999;48:971–3.
114. CDC. Multiple human exposures to a rabid bear cub at a petting zoo and barnwarming—Iowa, August 1999. *MMWR* 1999;48:761.
115. Robbins A, Eidson M, Keegan M, Sackett D, Laniewicz B. Bat incidents at children's camps, New York State, 1998–2002. *Emerg Infect Dis* 2005;11:302–5.
116. CDC. Tularemia associated with a hamster bite—Colorado, 2004. *MMWR* 2005;53:1202–3.
117. CDC. Fatal Cercopithecine herpesvirus 1 (B virus) infection following a mucocutaneous exposure and interim recommendations for worker protection. *MMWR* 1998;47:1073–6,1083.
118. Cohen JI, Davenport DS, Stewart JA, Deitchman S, Hilliard JK, Chapman LE. Recommendations for prevention of and therapy for exposure to B virus (Cercopithecine herpesvirus 1). *Clin Infect Dis* 2002;35:1191–203.
119. Hullinger G, Cole JJ, Elvinger F, Stewart R. Dermatophytosis in show lambs in the United States. *Vet Dermatol* 1999;10:73–6.
120. Scott WA. Ringworm outbreak [letter]. *Vet Rec* 1986;118:342.
121. Lederman ER, Austin C, Trevino I, et al. ORF virus infection in children: clinical characteristics, transmission, diagnostic methods, and future therapeutics. *Pediatr Infect Dis J* 2007;740–4.
122. Stover J, Dolensek E, Basford B, Beheny J. Contagious ecthyma in a children's zoo. *J Zoo An Med* 1986;17:115–6.
123. Marennikova SS, Maltseva NN, Korneeva VI, Garanina N. Outbreak of pox disease among Carnivora (Felidae) and edentata. *J Infect Dis* 1977;135:358–66.
124. Ninove L, Domart Y, Vervel C, et al. Cowpox virus transmission from pet rats to humans, France. *Emerg Infect Dis* 2009;15:781–4.
125. CDC. Update: Multistate outbreak of monkeypox—Illinois, Indiana, Kansas, Missouri, Ohio, and Wisconsin, 2003. *MMWR* 2003;52:642–6.
126. Kile JC, Fleishchauer AT, Kuehnert MJ, et al. Transmission of monkeypox among exposed daycare attendees: Indiana, 2003 [Abstract 51:132]. In: Programs and abstracts of the International Conference on Emerging Infectious Diseases, Atlanta, GA; February 29–March 3, 2004.
127. Nemetz TG, Shotts EB, Jr. Zoonotic diseases. In: Stoskopf MK. *Fish medicine*. Philadelphia, PA:WB Saunders; 1993:214–20.
128. Gray SE, Stanwell Smith R, Reynolds NJ, Williams EW. Fish tank granuloma. *BMJ*;300:1069–70.
129. Lewis FM, Marsh BJ, von Reyn CF. Fish tank exposure and cutaneous infections due to *Mycobacterium marinum*: tuberculin skin testing, treatment, and prevention. *Clin Infect Dis* 2003;37:390–7.
130. Angarano DW, Parish LC. Comparative dermatology: parasitic disorders. *Clin Dermatol* 1994;12:543–50.
131. Arlian LG. Biology, host relations, and epidemiology of *Sarcoptes scabiei*. *Annu Rev Entomol* 1989;34:139–61.
132. Scott DW, Horn RT, Jr. Zoonotic dermatoses of dogs and cats. *Vet Clin North Am Small Anim Pract* 1987;17:117–44.
133. Lucky AW, Sayers C, Argus JD, Lucky A. Avian mite bites acquired from a new source—pet gerbils. *Arch Dermatol* 2001;137:167–70.
134. Currier RW, 2nd, Kinzer GM, DeShields E. *Dipylidium caninum* infection in a 14-month-old child. *South Med J* 1973;66:1060–2.
135. Molina CP, Ogburn J, Adegboyega P. Infection by *Dipylidium caninum* in an infant. *Arch Pathol Lab Med* 2003;127:e157–9.
136. Schantz PM. *Toxocara larva migrans* now. *Am J Trop Med Hyg* 1989;41:21–34.
137. Michalak K, Austin C, Diesel S, Bacon MJ, Zimmerman P, Maslow JN. *Mycobacterium tuberculosis* infection as a zoonotic disease: transmission between humans and elephants. *Emerg Infect Dis* 1998;4:283–7.
138. Stetter MD, Mikota SK, Gutter AF, et al. Epizootic of *Mycobacterium bovis* in a zoologic park. *J Am Vet Med Assoc* 1995;207:1618–21.
139. Oh P, Granich R, Scott J, Sun B, Joseph M, Stringfield C, et al. Human exposure following *Mycobacterium tuberculosis* infection of multiple animal species in a metropolitan zoo. *Emerg Infect Dis* 2002;8:1290–3.
140. Kiers A, Klarenbeek A, Mendelts B, Soolingen D, Koeter G. Transmission of *Mycobacterium pinnipedii* to humans in a zoo with marine mammals. *Int J Tuberc Lung Dis* 2008;12:1469–73.
141. Murphree R, Warkentin JV, Dunn JR, Schaffner W, Jones TF. Elephant-to-human transmission of tuberculosis, 2009. *Emerg Infect Dis* 2011. Available at <http://www.cdc.gov/EID/content/17/3/366.htm>. Accessed April 4, 2011.
142. US National Tuberculosis Working Group for Zoo and Wildlife Species. Guidelines for the control of tuberculosis in elephants, 2008. Riverdale, MD: US National Tuberculosis Working Group for Zoo and Wildlife Species; 2008. Available at http://www.aphis.usda.gov/animal_welfare/downloads/elephant/elephant_tb.pdf.
143. Heymann D. Control of communicable diseases manual. 18th ed. Washington DC: American Public Health Association; 2004.
144. Milford F, Vibien A, Lambert L, Morin M, Petit G, Trottier J. Large Q-fever outbreak related to exposure to petting zoos in two shopping malls. In: Programs and abstracts of the 51st Annual Conference on Diseases in Nature Transmissible to Man; Austin, Texas; June 2001.
145. Smith KA, Campbell, CT, Murphy J, Stobierski MG, Tengelsen LA. Compendium of measures to control *Chlamydochloa psittaci* infection among humans (psittacosis) and pet birds (avian chlamydiosis), 2010. Available at <http://www.nasphv.org/Documents/Psittacosis.pdf>.
146. Christensen A, Jarlov J, Ingeberg S. The risk of ornithosis among the staff of Copenhagen Zoo. *Ugeskr Laeger* 1990;152:818–20.
147. Eidson M. Psittacosis/avian chlamydiosis. *J Am Vet Med Assoc* 2002;221:1710–2.
148. Hyde SR, Benirschke K. Gestational psittacosis: case report and literature review. *Mod Pathol* 1997;10:602–7.
149. Yassine HM, Khatri M, Zhang YJ, et al. Characterization of triple reassortant H1N1 Influenza A viruses from swine in Ohio. *Vet Micro* 2009;139: 132–139.
150. Shinde V, Bridges C, Uyeki T, et al. Triple-reassortment swine influenza A (H1) in humans in the United States, 2005–2009. *N Engl J Med* 2009;360:2616–25.
151. Neises D, Trevino-Garrison I, Cox C, et al. Human case of swine influenza A (H3N2) virus infection—Kansas, 2009. In: Programs and abstracts of the Council of State and Territorial Epidemiologists 3rd Annual Conference, Portland, Oregon; June 6–10, 2010.
152. Vincent A, Swenson S, Lager K, Gauger P, Loiacono C, Zhang Y. Characterization of an influenza A virus isolated from pigs during an outbreak of respiratory disease in swine and people during a county fair in the United States. *Vet Micro* 2009;137:51–9.
153. Wells D, Hopfensperger D, Arden N, et al. Swine influenza virus infections: transmission from ill pigs to humans at a Wisconsin agricultural fair and subsequent probable person-to-person transmission. *J Amer Med Assoc* 1991;265:478–81.

Recommendations and Reports

154. Vincent A, Ma W, Lager K, Janke B, Richt J. Swine influenza viruses: a North American perspective. *Adv Virus Res* 2008;72:127–54.
155. Howden KJ, Egan JB, Francois DC, et al. An investigation into human pandemic influenza virus (H1N1) 2009 on an Alberta swine farm. *Can Vet J* 2009;50:1153–61.
156. Casemore D. Educational farm visits and associated infection hazards. *Commun Dis Rep CDR Rev* 1989;19:3.
157. Dawson A, Griffin R, Fleetwood A, Barrett NJ. Farm visits and zoonoses. *Commun Dis Rep CDR Rev* 1995;5:81–6.
158. Warshawsky B, Henry B, Gutmanis I, et al. An *E. coli* O157:H7 outbreak associated with an animal exhibit: Middlesex-London Health Unit investigation and recommendations—executive summary. Vol. 2006. Middlesex, London; Ontario, Canada: Middlesex-London Health Unit; 1999.
159. Washington State Department of Health. Recommendations to reduce the risk of disease transmission from animals to humans at petting zoos, fairs and other animal exhibits. Olympia, WA: Washington State Department of Health, Office of Environmental Health and Safety, 2001. Available at <http://kitsap.wsu.edu/4h/fair/recommendationspettingzoo.pdf>.
160. Animal Exhibition Sanitation Act 211 of 2002. Pennsylvania Bureau of Animal Health and Diagnostic Services. May 6, 2002. Available at <http://www.agriculture.state.pa.us/agriculture/lib/agriculture/legal/reference/act211of2002.pdf>.
161. Commonwealth of Massachusetts Department of Public Health. Recommendations for petting zoos, petting farms, animal fairs, and other events and exhibits where contact between animals and people is permitted. Boston, MA: Commonwealth of Massachusetts Department of Public Health, Bureau of Communicable Disease Control; 2004. Available at http://www.mass.gov/Eeohhs2/docs/dph/cdc/rabies/reduce_zoos_risk.pdf.
162. Association of Zoos and Aquariums. The accreditation standards and related policies. 2010 edition. Silver Spring, MD: Association of Zoos and Aquariums; 2010. Available at <http://www.aza.org>.
163. CDC. Reptile-associated salmonellosis—selected states, 1998–2002. *MMWR* 2003;52:1206–9.
164. CDC. Healthy pets healthy people. Atlanta, GA: US Department of Health and Human Services, CDC; 2004. Available at <http://www.cdc.gov/healthypets>.
165. National Association of State Public Health Veterinarians. Compendium of animal rabies prevention and control, 2008. Available at <http://www.nasphv.org/Documents/RabiesCompendium.pdf>.
166. Singleton SL, Poole S, Scheffel J, Smith K, Bender JB. Observational study regarding incorporation of measures to prevent disease outbreaks associated with animals in public settings. 2008. Board 197. In: Programs and abstracts of the International Conference on Emerging Infectious Diseases, Atlanta, GA; March 16–19, 2008.
167. Bondeson L. Assessment of measures to prevent disease associated with animals in agricultural fairs—Maine, 2008. *Am J Infect Control* 2009;37:665–7.
168. Midwest Plan Service. Heating, cooling and tempering air for livestock housing. Ames, IA: Iowa State University; 1990.
169. Ross C, Morrow PS. Q fever: an issue in occupational health & safety? An overview of the methods of control and the effects of *Coxiella burnetii* on the human host. *J R Soc Health* 1994;114:151–2.

Appendix A

Animals in Public Settings: Guidelines for Venue Operators and Staff Members

Operators and staff members should be aware of the following risks for disease and injury associated with animals in public settings:

- Disease and injuries have occurred following contact with animals and their environment.
- Healthy animals can carry germs that make visitors sick.
- Visitors can pick up germs when they touch animals or animal droppings or enter an animal's environment.
- Visitors can rid themselves of most germs if they wash their hands immediately after leaving an animal area. Visitors should wash their hands even if they did not directly contact the animals.
- The risk for developing serious or life-threatening illnesses from contact with animals is higher among certain visitors, especially young children (i.e., aged <5 years), older adults, pregnant women, and persons with weakened immune systems.

Operators and staff members should take the following steps to maintain a safe environment when animals are present in public settings:

- Design the venue with safety in mind by having designated animal areas, nonanimal areas, and transition areas.
- Do not permit any animals other than service animals in nonanimal areas.
- Provide hand-washing facilities where food and beverages are prepared, served, or consumed.
- Assign trained staff members to monitor animal contact areas.
- Exclude food and beverages, toys, pacifiers, spill-proof cups, and baby bottles, and prohibit smoking in animal contact areas.
- Keep the animal areas as clean and disinfected as possible, and limit visitor contact with manure and animal bedding.
- Allow feeding of animals only if contact with animals can be controlled (e.g., over a barrier).

- Minimize use of animal areas for public activities (e.g., weddings, dances).
- Design transition areas for entering and exiting animal areas with appropriate signs or other forms of notification regarding risks of animal contact and location of hand-washing facilities.
- Maintain hand-washing stations that are accessible to children, and direct visitors to wash their hands when exiting animal areas.
- Position hand-washing stations in places that encourage hand washing when exiting animal areas.
- Ensure that animals receive appropriate preventive care, including vaccinations and parasite control.
- Provide potable water for animals.
- Prohibit consumption of unpasteurized dairy products (e.g., raw milk) and juices.

Operators and staff members should educate visitors regarding animal contact in public settings:

- Inform visitors about the risks for disease and injury before they enter animal areas.
- Provide simple instructions in multiple age- and language-appropriate formats.
- Direct visitors to wash their hands and assist children with hand washing immediately after visiting an animal area.
- Advise visitors that they should not eat, drink, or place things in their mouths after animal contact or visiting an animal area until they have washed their hands.
- Advise visitors to closely supervise children and to be aware that objects such as clothing, shoes, and stroller wheels can become soiled and serve as a source of germs after leaving an animal area.
- Make visitors aware that young children, older adults, pregnant women, and persons who are immunocompromised are at increased risk for serious illness.

Appendix B

Suggested Sign or Handout for Visitors to Petting Zoos*

Know that animals carry germs that can make people sick

Never eat, drink, or put things into your mouth in animal areas

Older adults, pregnant women, and young children should be extra careful around animals

Wash your hands with soap and water right after visiting the animal area

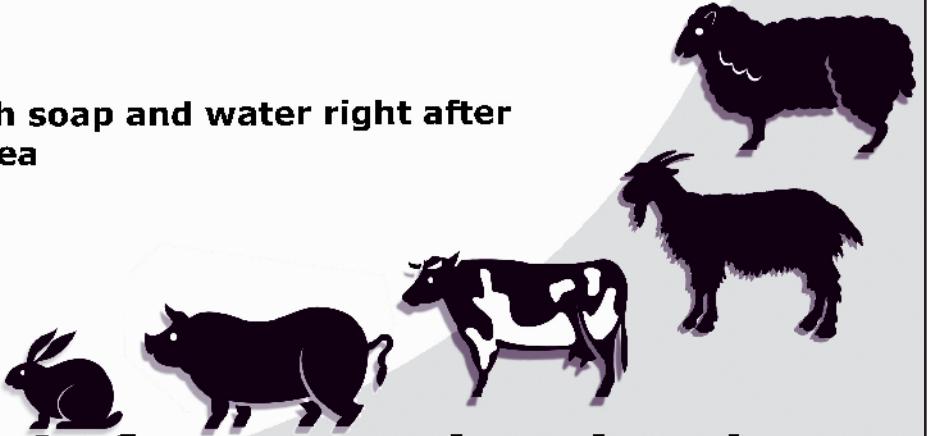

How to be Safe Around Animals!

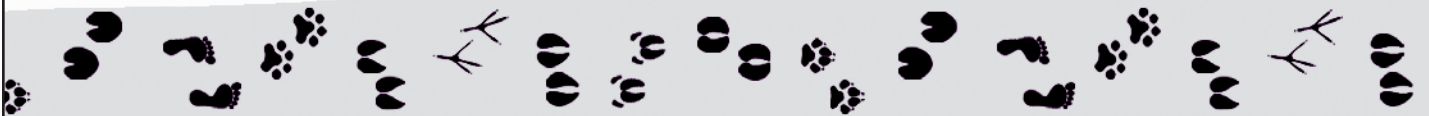

* Sign available at <http://www.nasphv.org/documentscompendiaanimals.html>. Additional information on animals in public settings and zoonotic diseases is available at <http://www.cdc.gov/healthypets>.

Appendix C

Hand-Washing Recommendations to Reduce Disease Transmission from Animals in Public Settings

Hand washing is the most important prevention step for reducing disease transmission associated with animals in public settings. Hands should always be washed immediately when exiting animal areas, after removing soiled clothing or shoes, and before eating or drinking. Venue staff members should encourage hand washing as persons exit animal areas.

How to Wash Hands

- Wet your hands with clean, running water (warm or cold) and apply soap; rub your hands together to make a lather and scrub them well (be sure to scrub the backs of your hands, between your fingers, and under your nails); continue rubbing your hands for at least 20 seconds; rinse your hands well under running water.
- If possible, turn off the faucet using a disposable paper towel.
- Dry your hands using a clean disposable paper towel or air dry them. Do not dry hands on clothing.
- Assist young children with washing their hands.

Hand-Washing Facilities or Stations

- Hand-washing facilities or stations should be accessible, sufficient for the maximum anticipated attendance, and accessible by children (i.e., low enough for children to reach or equipped with a stool), adults, and persons with disabilities.
- Hand-washing facilities stations should be conveniently located in transition areas between animal and nonanimal areas and in the nonanimal food concession areas.
- Maintenance of hand-washing facilities and stations should include routine cleaning and restocking to ensure an adequate supply of paper towels and soap.
- Running water should be of sufficient volume and pressure to remove soil from hands. Volume and pressure might be substantially reduced if the water supply is furnished from a holding tank; therefore, a permanent pressurized water supply is preferable.
- Hand-washing stations should be designed so that both hands are free for hand washing by having operation with a foot pedal or water that stays on after hand faucets are turned on.
- Liquid soap dispensed by a hand or foot pump is recommended.
- Hot water is preferable, but if the hand-washing facilities or stations are supplied with only cold water, a soap that emulsifies easily in cold water should be provided.
- Communal basins, in which water is used by more than one person, are not adequate hand-washing facilities.

Hand-Sanitizing Agents

- Washing hands with soap and water is the best way to reduce the number of germs on them.
- If soap and water are not available, use an alcohol-based hand sanitizer that contains at least 60% alcohol.
- Visible contamination and dirt should be removed before using hand sanitizers. Hand sanitizers are not effective when hands are visibly dirty.
- Even when hand sanitizer is used, visitors should always wash hands with soap and water as soon as possible after being in animal areas.
- Alcohol-based hand sanitizers can quickly reduce the number of germs on hands in some situations, but sanitizers do not eliminate all types of germs.

How to Use Hand Sanitizers

- Apply the product to the palm of one hand.
- Rub your hands together.
- Rub the product over all surfaces of your hands and fingers until your hands are dry.

Hand-Washing Signs

- At venues where human-animal contact occurs, signs regarding proper hand-washing practices are critical to reduce disease transmission.
- Signs that remind visitors to wash hands should be posted at exits from animal areas (i.e., exit transition areas) and in nonanimal areas where food is served and consumed (Figure).
- Signs should be posted that direct all visitors to hand-washing stations when exiting animal areas.
- Signs with proper hand-washing instructions should be posted at hand-washing stations and restrooms to encourage proper practices.
- If appropriate for the setting, hand-washing signs should be available in different languages.

Wash Hands When Leaving Animal Exhibits





WHO



Everyone, especially young children, older individuals, and people with weakened immune systems







WHEN

Always Wash Hands:

-  After touching animals or their living area
-  After leaving the animal area
-  After taking off dirty clothes or shoes
-  After going to the bathroom
-  Before preparing foods, eating, or drinking



HOW

-  Wet your hands with clean, running water
-  Apply soap
-  Rub hands together to make a lather and scrub well, including backs of hands, between fingers, and under fingernails
-  Rub hands at least 20 seconds. Need a timer? Hum the “Happy Birthday” song from beginning to end twice
-  Rinse hands
-  Dry hands using a clean paper towel or air dry them. Do not dry hands on clothing



For more information, visit CDC's Healthy Pets, Healthy People website (www.cdc.gov/healthypets) and CDC's Handwashing website (www.cdc.gov/handwashing).

Appendix D

Guidelines for Animals in School and Child-Care Settings

Animals are effective and valuable teaching aids, but safeguards are required to reduce the risk for infection and injury. The following guidelines are a summary of guidelines developed by the Alabama Department of Public Health,^{*} the Kansas Department of Health and Environment,[†] and CDC (78,79). Recommendations also are available from the National Science Teachers Association[§] and the National Association of Biology Teachers.[¶]

General Guidelines for School Settings**

- Wash hands after contact with animals, animal products or feed, or animal environments.
- Supervise human-animal contact, particularly involving children aged <5 years.
- Display animals in enclosed cages or under appropriate restraints.
- Do not allow animals to roam, fly free, or have contact with wild animals.
- Designate specific areas for animal contact.
- Do not allow food in animal contact areas; do not allow animals in areas where food and drink are prepared, served, or consumed.
- Clean and disinfect all areas where animals and animal products have been present. Children should perform this task only under adult supervision.
- Do not clean animal cages or enclosures in sinks or other areas used to prepare, serve, or consume food and drinks.
- Obtain appropriate veterinary care, a certificate of veterinary inspection, or proof of rabies vaccination (or all of these) according to local or state requirements.

- Keep animals clean and free of intestinal parasites, fleas, ticks, mites, and lice.
- Parents should be informed of the benefits and potential risks associated with animals in school classrooms. Consult with parents to determine special considerations needed for children who are immunocompromised, have allergies, or have asthma.
- Ensure that personnel providing animals for educational purposes are knowledgeable regarding animal handling and zoonotic disease issues. Persons or facilities that display animals to the public should be licensed by the U.S. Department of Agriculture.

Animal-Specific Guidelines

- **Fish:** Use disposable gloves when cleaning aquariums, and do not dispose of aquarium water in sinks used for food preparation or for obtaining drinking water.
- **Psittacine birds (e.g., parrots, parakeets, and cockatiels):** Consult the psittacosis compendium,^{††} and seek veterinary advice. Use birds treated or that test negative for avian chlamydiosis.
- **Nonpsittacine birds:** See General Guidelines for School Settings.
- **Domestic dogs, cats, rabbits, and rodents (e.g., mice, rats, hamsters, gerbils, guinea pigs, and chinchillas):** See General Guidelines for School Settings.
- **Reptiles (e.g., turtles, snakes, and lizards):** Do not keep in facilities with children aged <5 years, nor should children aged <5 years be allowed to have direct contact with these animals.
- **Amphibians (e.g., frogs, toads, salamanders, and newts):** Do not keep in facilities with children aged <5 years, nor should children aged <5 years be allowed to have direct contact with these animals.
- **Live poultry (e.g., chicks, ducklings, and goslings):** Do not keep in facilities with children aged <5 years, nor should children aged <5 years be allowed to have direct contact with these animals.

* WB Johnston, DVM, Alabama Department of Public Health, personal communication, 2002.

† Hansen GR. Animals in Kansas schools: guidelines for visiting and resident pets. Topeka, KS: Kansas Department of Health and Environment; 2004. Available at <http://www.kdhe.state.ks.us/pdf/hef/ab1007.pdf>.

§ National Science Teachers Association. National standards for science teacher preparation. Arlington, VA: National Science Teachers Association; 2003. Available at <http://www.nsta.org/preservice>.

¶ National Association of Biology Teachers. The use of animals in biology education. Reston, VA: National Association of Biology Teachers; 2008. Available at <http://www.nabt.org/websites/institution/File/docs/use%20of%20animals.pdf>.

** Guide, hearing, or other service animals and law enforcement animals may be used when they are under the control of a person familiar with the specific animal and in accordance with recommendations from the sponsoring organizations.

†† National Association of State Public Health Veterinarians. Compendium of measures to control *Chlamydophila psittaci* infection among humans (psittacosis) and pet birds (avian chlamydiosis), 2010. Available at <http://www.nasphv.org/documents/CompendiaPsittacosis.html>.

- **Ferrets:** Do not keep in facilities with children aged <5 years, nor should children aged <5 years be allowed to have direct contact with these animals to prevent bites.
- **Farm animals:** See General Guidelines for School Settings. Certain animals (e.g., young ruminants and baby poultry) intermittently excrete substantial numbers of germs; therefore, these farm animals are not appropriate in school or child-care settings unless meticulous attention to personal hygiene can be ensured.
- **Animal products:** Assume that products such as owl pellets and frozen rodents used to feed reptiles are contaminated with *Salmonella* organisms. Owl pellets should not be dissected in areas where food is prepared, served, or consumed. Children aged <5 years should not be allowed to have direct contact with animal products.

Animals Not Recommended in School or Child-Care Settings

- Inherently dangerous animals (e.g., lions, tigers, cougars, and bears).
- Nonhuman primates (e.g., monkeys and apes).
- Mammals at high risk for transmitting rabies (e.g., bats, raccoons, skunks, foxes, and coyotes).
- Aggressive or unpredictable wild or domestic animals.
- Stray animals with unknown health and vaccination history.
- Venomous or toxin-producing spiders, insects, reptiles, and amphibians.

National Association of State Public Health Veterinarians, Inc., Committee

Co-chairpersons: John R. Dunn, DVM, Tennessee Department of Health, Nashville, Tennessee; Kirk E. Smith, DVM, Minnesota Department of Health, St. Paul, Minnesota.

Members: Carina Blackmore, DVM, Florida Department of Health, Tallahassee, Florida; Louisa Castrodale, DVM, Alaska Department of Health and Social Services, Anchorage, Alaska; Ron Wohrle, DVM, Washington State Department of Health, Olympia, Washington; James H. Wright, DVM, Texas Department of State Health Services, Tyler, Texas.

Consultants to the Committee: Marianne Ash, DVM, American Veterinary Medical Association Council on Public Health and Regulatory Veterinary Medicine, Schaumburg, Illinois; Casey Barton Behraves, DVM, CDC, Atlanta, Georgia; Karen Beck, DVM, North Carolina Department of Agriculture and Consumer Services, Raleigh, North Carolina; Marla J. Calico, International Association of Fairs and Expositions, Springfield, Missouri; Allan Hogue, DVM, US Department of Agriculture, Riverdale, Maryland; Carla Huston, DVM, American Association of Extension Veterinarians, Starkville, Mississippi; Timothy F. Jones, MD, Council of State and Territorial Epidemiologists, Atlanta, Georgia; Thomas P. Meehan, DVM, Association of Zoos and Aquariums, Silver Spring, Maryland.

Recommendations and Reports

The *Morbidity and Mortality Weekly Report (MMWR)* Series is prepared by the Centers for Disease Control and Prevention (CDC) and is available free of charge in electronic format. To receive an electronic copy each week, visit MMWR's free subscription page at <http://www.cdc.gov/mmwr/mmwrsubscribe.html>. Paper copy subscriptions are available through the Superintendent of Documents, U.S. Government Printing Office, Washington, DC 20402; telephone 202-512-1800.

Address all inquiries about the *MMWR* Series, including material to be considered for publication, to Editor, *MMWR* Series, Mailstop E-90, CDC, 1600 Clifton Rd., N.E., Atlanta, GA 30333 or to mmwrq@cdc.gov.

All material in the *MMWR* Series is in the public domain and may be used and reprinted without permission; citation as to source, however, is appreciated.

Use of trade names and commercial sources is for identification only and does not imply endorsement by the U.S. Department of Health and Human Services.

References to non-CDC sites on the Internet are provided as a service to *MMWR* readers and do not constitute or imply endorsement of these organizations or their programs by CDC or the U.S. Department of Health and Human Services. CDC is not responsible for the content of these sites. URL addresses listed in *MMWR* were current as of the date of publication.

☆ U.S. Government Printing Office: 2011-723-011/21046 Region IV ISSN: 1057-5987